

# Help for Homes

## Tips to Build Back Safer



**How to make your house more resilient to natural disaster**



# Help for Homes

## Tips to Build Back Safer

### Table of Contents

<b>Foreword</b>	3
1. Site your house safely	5
2. Build on strong foundations	7
3. Tie down from bottom up & use strong joints - nails are not enough	9
4. Brace against the storm	11
5. A good house needs a good roof	13
6. Leave nobody behind	15
7. Be prepared	17
<i>These tips will make your house stronger,</i> poster	18
<i>Simple roofing tips,</i> poster	20
<i>The traditional housing way,</i> poster	22
<i>A little money goes a long way,</i> poster	24
<i>When nails are not enough,</i> poster	26
<i>Retrofit your existing house</i> poster	28
Resources on Building Back Safer	31
Disclaimer, credits and partners	32

© Shelter Cluster Fiji, 2016

This is an open source document. Copies of all or part of this manual may be made for noncommercial use, providing the source is acknowledged.

Proper construction of the structures and techniques in this brochure, remain the responsibility of the individual, company or organization constructing them.

Partners who contributed to the development of this documents are acknowledged on top of page 32. If you want to reprint it, you could include your logo on the bottom of page 32, but not on the outsided cover of this document.

Cover photo: Building Back Safer training run by Shelter Cluster Fiji and Habitat for Humanity in May 2016 (source Shelter Cluster Fiji)





This house survived unscathed from TC Winston, when nearly all else around it was destroyed. Note strapping on every joint, diagonal bracing on the wall and roof panels and metal plates on the truss timbers. (Source Habitat for Humanity)



This house was built after TC Winston with Build Back Safer principles. (Source Fiji Red Cross Society/IFRC).

## Why Building Back Safer is important

After Cyclone Winston destroyed more than 31,200 houses, a massive rebuilding effort was initiated across the country through the Government of Fiji's "Help for Homes" initiative, that provided vouchers to enable those affected with destroyed or damaged homes to purchase building materials.

Current monitoring of shelter recovery indicates that despite strong resilience, people are rebuilding with minimum resources and same construction methods as before, which will lead to weak structures, increasing the vulnerability of Fiji to future cyclones or natural disasters.

This booklet aims to provide simple Build Back Safer tips to allow better understanding of construction principles and measures to make your house stronger and more resilient to natural disaster.

**Mr Kolinio Bola,**  
**Director of Housing, Shelter Cluster Fiji Lead**

# Tips to Build Back Safer

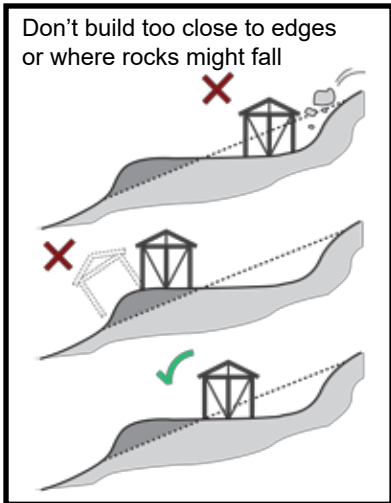

## 1. Site your house safely

- ✓ Build your house on a safe site by identifying and trying to avoid potential hazards and build as well as you can to resist them.
- ✓ Certain vulnerable settings need to be avoided, such as hilltops, coastal zones, flood plains and valley mouths.
- ✓ Raise your house in a flood-prone situation.

## HOW SHOULD WE PLAN A GROUP OF BUILDINGS?

Houses too close together trap wind

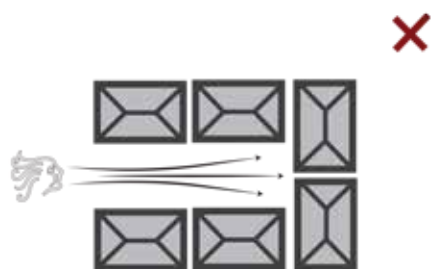

Spacing houses to let the wind pass

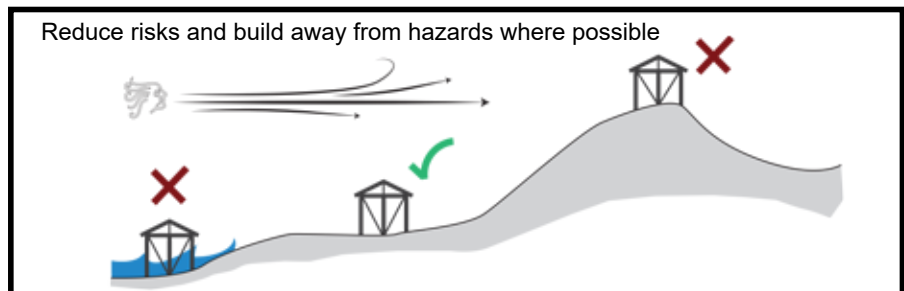
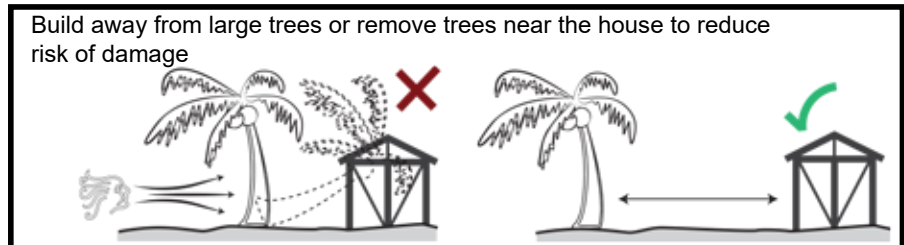

# Tips to Build Back Safer

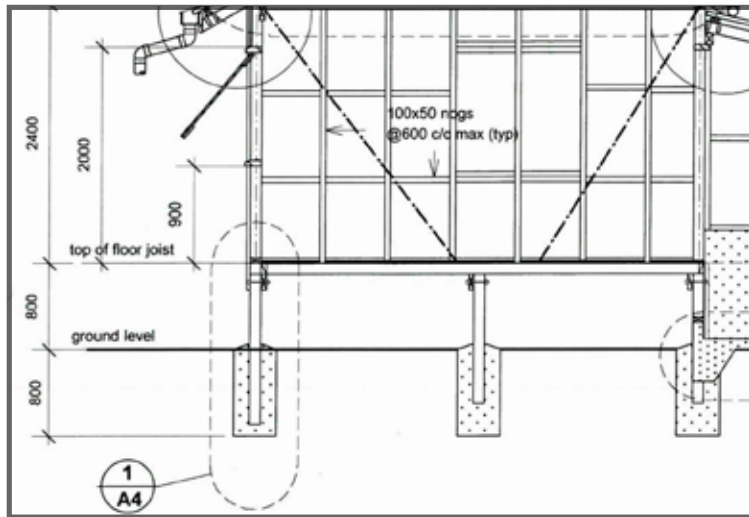

Core shelter design with strong foundation. (Source Fiji Red Cross Society/IFRC).

## 2. Build on strong foundations

- ✓ Deeply anchor your house to the ground with strong foundations, setting the posts at least 0.75 metres deep in the ground. Posts and stumps should be spiked and set in concrete.
- ✓ Ensure foundations are suitable to your building's location and ground conditions.

### WHAT CAN I USE AS A FOUNDATION FOR MY HOUSE?

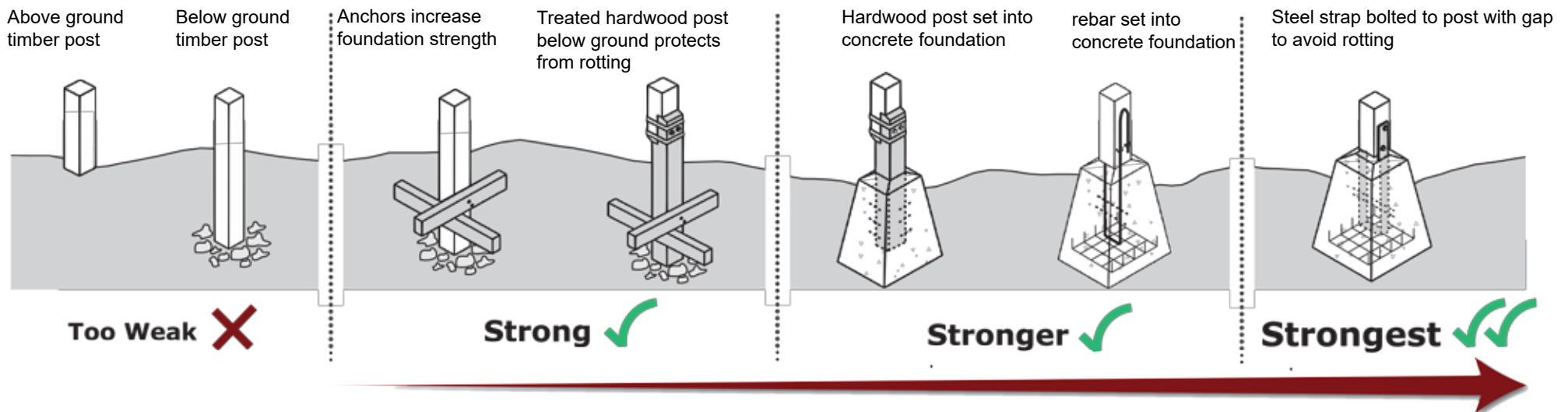



# Tips to Build Back Safer



Strapping should be long enough to hold four (4) nails on each side. Note that the diagonal bracing is stretched tight and is wrapped around the frame at the ends. Note also the double top-plate to support the roof frame.

## 3. Tie down from bottom up & use strong joints - Nails are not enough

- ✓ Ensure that you have strong connections at all joints - the roof material to the roof timbers, the roof to the walls and the walls to the foundations.
- ✓ Each joints of your house must be reinforced with more than nails.
- ✓ Build every joint so it can't be pushed or pulled apart. Nails alone are not sufficient to hold joints together when subject to cyclonic forces. Strong connections can be made with cyclone straps, rope and wire.

### WHAT CAN I USE TO TIE DOWN MY HOUSE?

Rope or nylon fishing wire

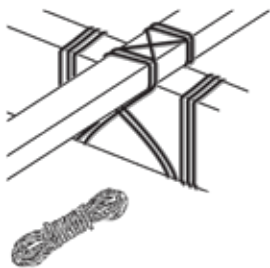

Thick galvanised wire (multiple layers)

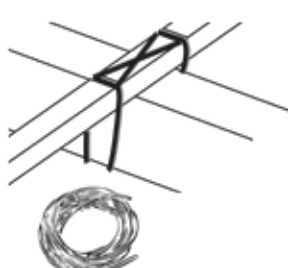

**Strong** ✓

Timber Cleats

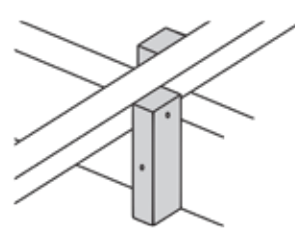

Galvanised metal strap

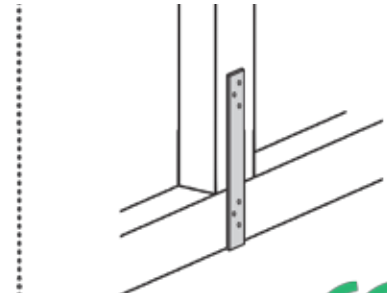

**Strongest** ✓✓

### STRONG WINDS COMING?

Tie down when strong winds come

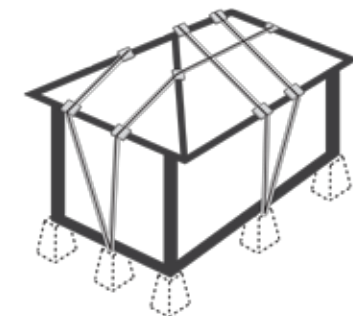

# Tips to Build Back Safer



## 4. Brace against the storm

- ✓ Strong bracing stops your house from being pushed over or pulled apart by the wind.
- ✓ Brace between the strong points of your house.
- ✓ All wall and roof panels should be diagonally braced.

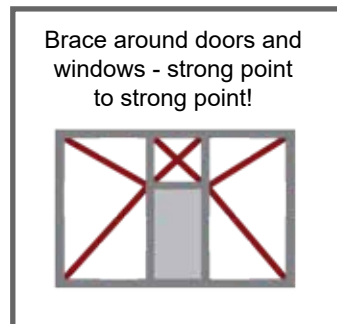
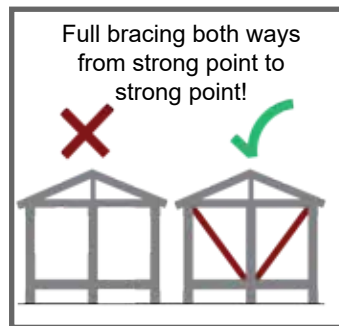
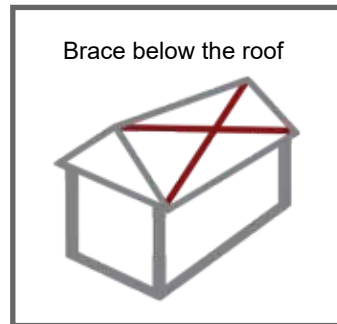
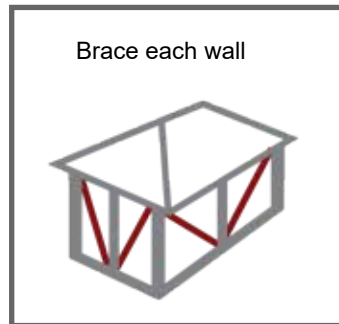

## WHAT CAN I USE TO BRACE MY HOUSE?

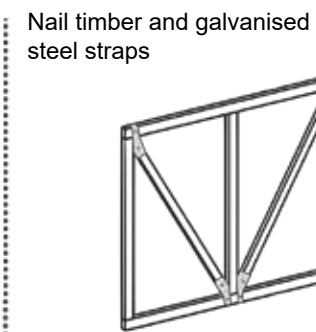
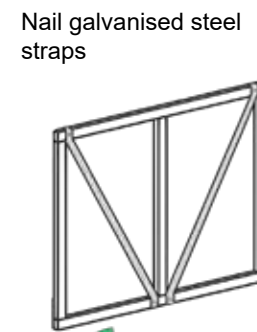
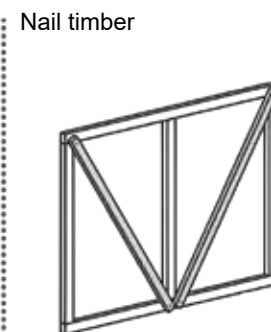
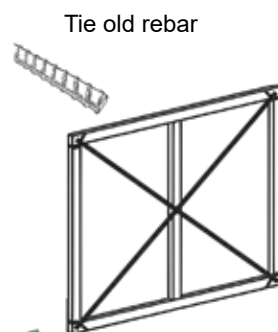
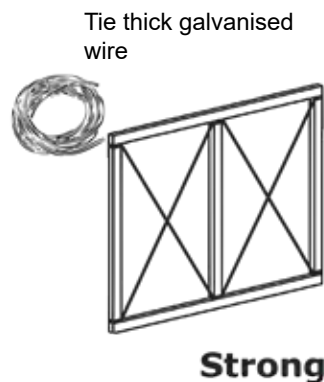

**Stronger** ✓

**Strongest** ✓✓

# Tips to Build Back Safer

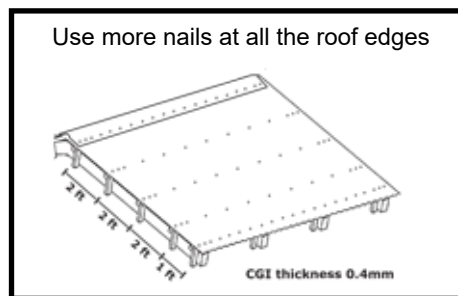
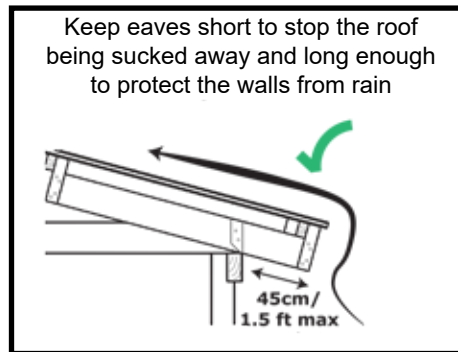
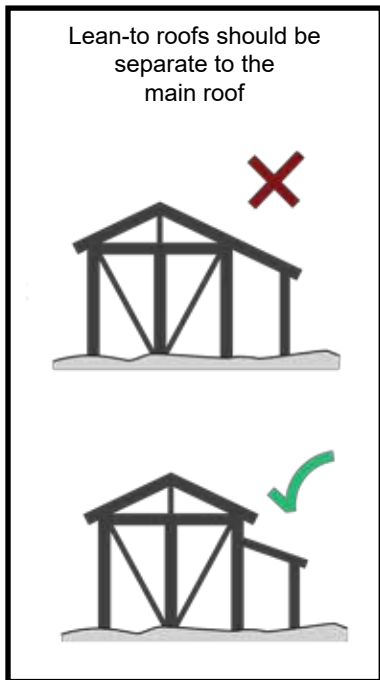

## 5. A good house needs a good roof

- ✓ Build your roof with the right shape and pitch, and nail down well to protect against a storm. A roof with 4 slopes (hip), and slopes within the 30 to 45 degree range, is best able to cope with cyclonic winds.
- ✓ Roofing iron is best secured with cyclonic screws, with each flute fastened around the edges.
- ✓ Porches and verandas should be constructed on separate wall plates, rather than be continuous with the main roof.
- ✓ Eaves should be minimised, with 45 centimetres considered the maximum span.

## WHAT ROOF SHAPE SHOULD I USE?

Two-sided gable roof



**Strong** ✓

Multiple roof slopes reduce the risk of your roof being pulled apart



**Strongest** ✓✓





# Tips to Build Back Safer

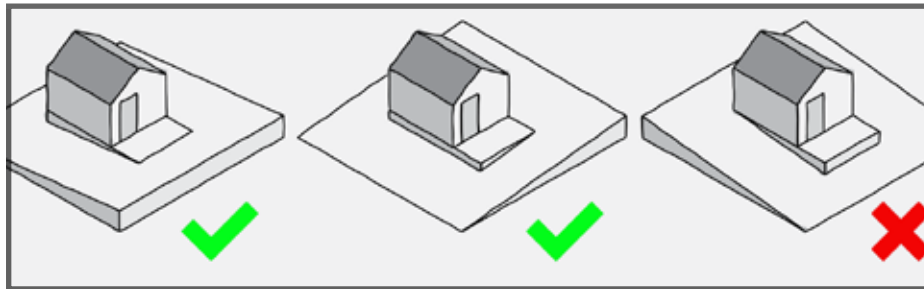

Minimise the difference between the ground level inside and outside the shelter. If there is a slope, try to use this to your advantage by placing the entrance at the upper end of the site.

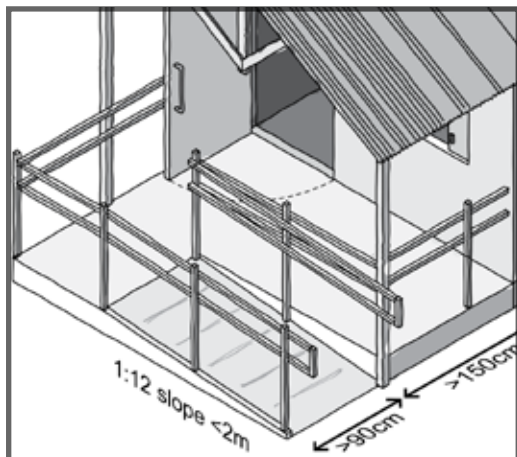

Install handrails on ramps and porch to improve access and safety for persons with reduced mobility or visual impairment.

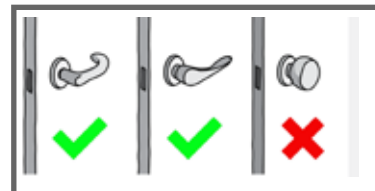

Provide doors and windows that are light and easy to open and close with accessible handles. Adapt to different types of disability as needed.

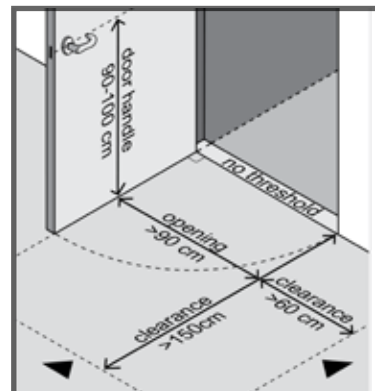

*\*All drawings are from the Under One Roof guideline on disability inclusive shelter and settlements in emergencies*

## 6. Leave nobody behind

- ✓ Building Back Safer should include the minimum measures to enhance accessibility of your house for people with current or future physical impairments. It's cheaper to include them while you're rebuilding rather than to retrofit your house later.
- ✓ Site the house so that any steep slope is at the back, rather than at the entrance.
- ✓ Use ramps instead of (or as well as) steps. Ramps should have a slope of between 1:10 and 1:12, be at least 900mm wide, have a non-slip surface and a kerb on each side.
- ✓ Handrails should be installed, at a minimum on the ramp, porch, toilet and shower.
- ✓ All doors should be a minimum of 90 centimetres wide, with a lever-type handle about 1 metre off the floor, and there should be no doorsill.
- ✓ Toilet, bathroom and shower doors should all open outwards.

# Tips to Build Back Safer



## 7. Be prepared

- ✓ Preparedness is critical because it is the main way to reduce the impacts of a disaster.
- ✓ All openings in walls should have a means of shuttering. It is important to start taking action and prepare now.
- ✓ If a disaster is coming, you should tie down your house, protect windows and openings, elevate valuable items during floods and secure loose items so they won't be blown away.

Add bracing  
Prepare strong "safe room"  
Add shutters to windows and openings  
Remove large trees close to house  
Create wind breaks



### HOW CAN I PREPARE MY HOUSE, MYSELF AND MY COMMUNITY FOR A DISASTER?



#### EVACUATION ✓

Make a plan and practice it  
Decide early if you will evacuate or stay in place  
Prepare safe evacuation route  
Know where the evacuation centres and sites are  
Know what transport you can use



#### COMMUNICATION ✓

Know the disaster warning signals  
Know how you can receive information about a disaster  
Inform your relatives and friends where you will evacuate to  
Know how you will communicate with relatives and friends

after the disaster  
Know how and whom to inform  
Know where to find information on missing persons



#### GRAB BAG ✓

Prepare a waterproof "Grab Bag" prior to a disaster  
Make the "Grab Bag" easy to carry and include:  
Medication & medical kit  
• Extra clothing and safe shoes  
• Batteries  
• Torch and matches  
• Basic food  
• Cooking equipment  
• Basic tools  
• Important personal records/ID in waterproof bag  
• Don't forget some water



**THESE TIPS  
WILL MAKE  
YOUR  
HOUSE  
STRONGER**

# Tips to Build Back Safer

BUILD SAFER  
BUILD WISER. THIS WILL SAVE  
YOU MONEY. MAKE SURE YOU DON'T  
MISS ANYTHING OUT  
...HAPPY BUILDING!!

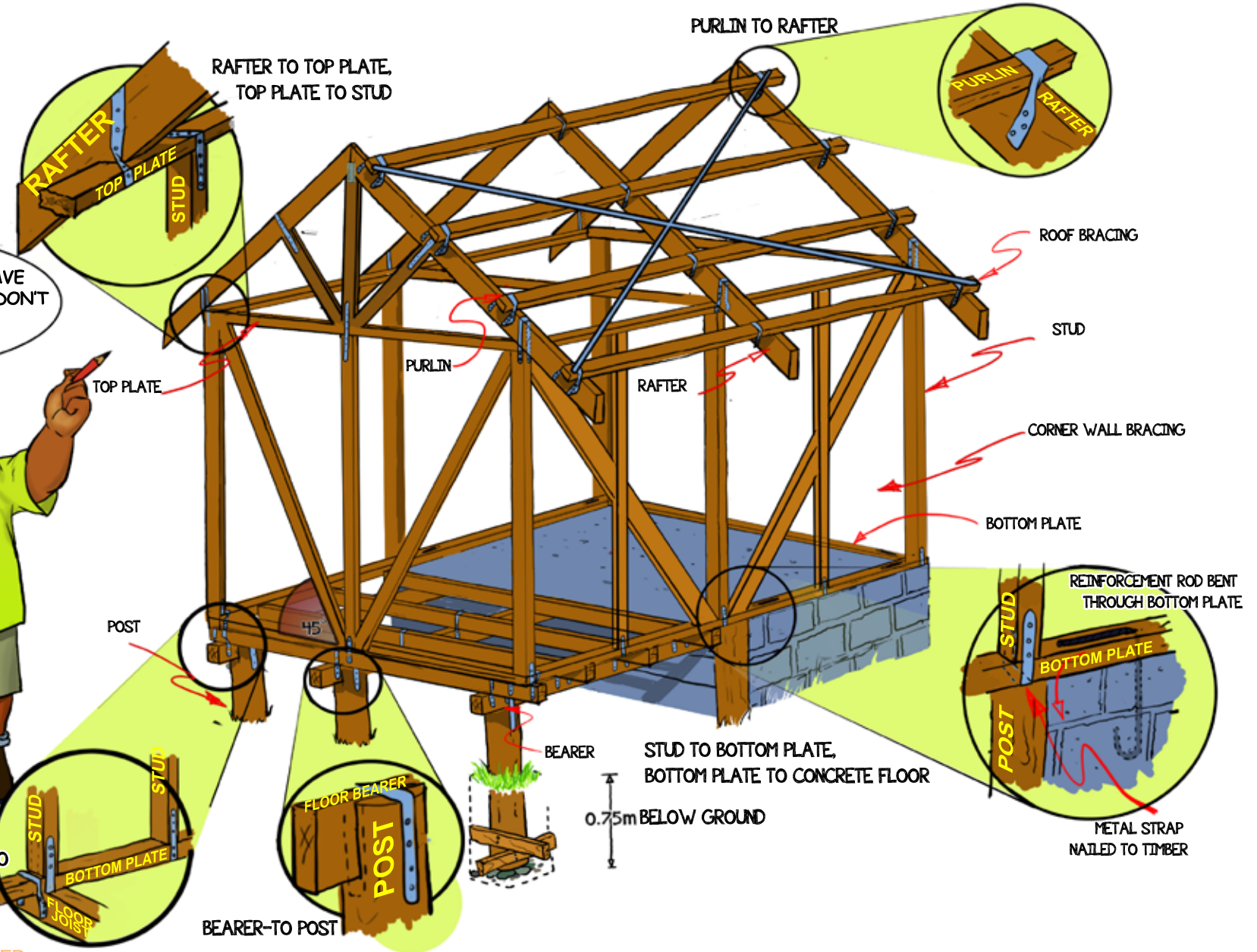

Original work and  
Supported by:





# Tips to Build Back Safer



**Shelter Cluster Fiji**  
ShelterCluster.org  
Coordinating Humanitarian Shelter

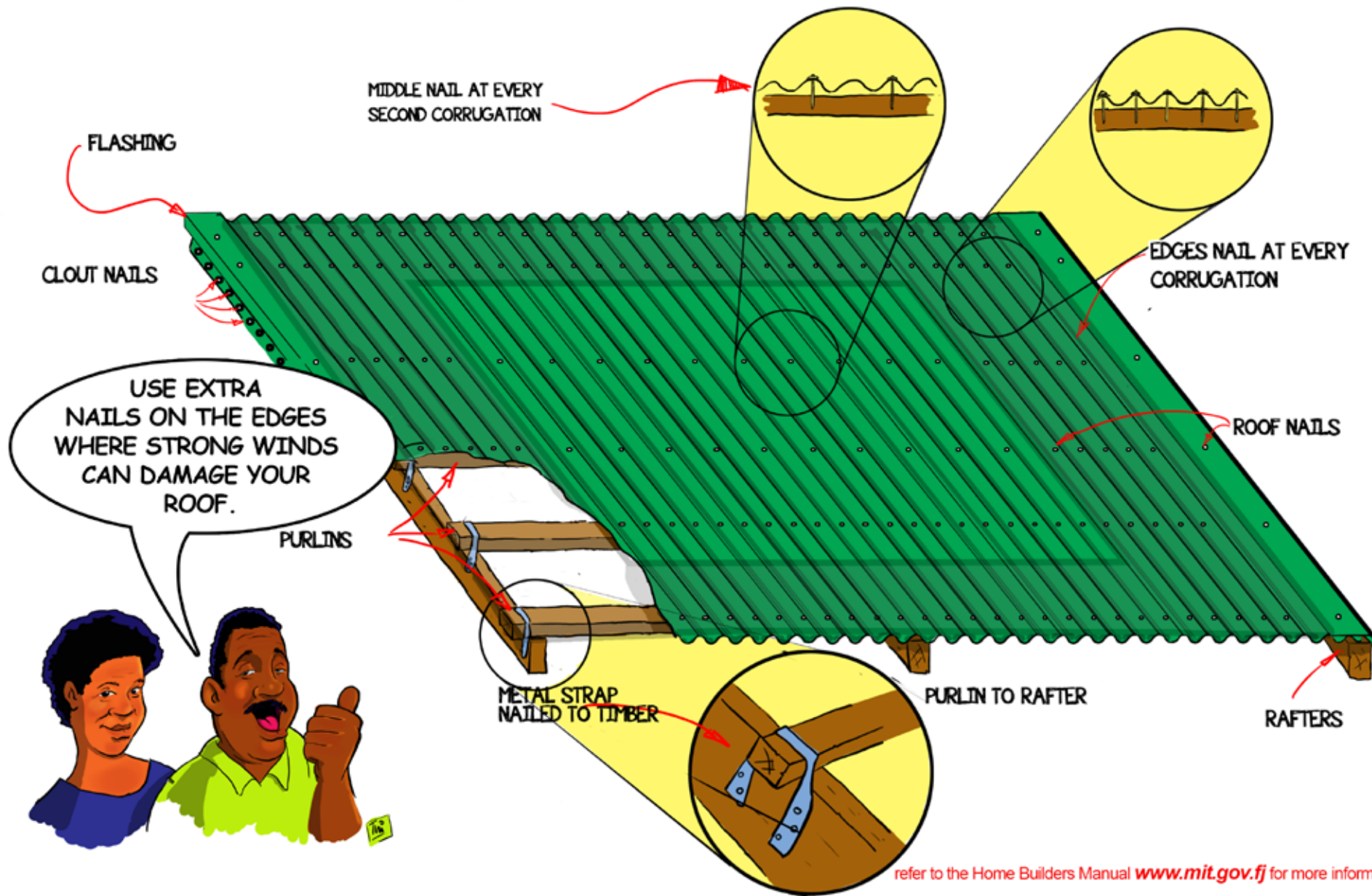

refer to the Home Builders Manual [www.mit.gov.fj](http://www.mit.gov.fj) for more information

# THE TRADITIONAL WAY: LEARNING FROM HISTORY

## FIJI

BASELINE DATA ON LOCAL BUILDING CULTURE & COPING STRATEGIES



## COPING WITH CYCLONES & OTHER NATURAL RISKS

1 LARGE HARDWOOD POSTS BURIED DEEPLY IN THE GROUND

1



Traditional bare house (Divaughn)

2 STEEPLY PITCHED, FOUR SIDED ROOFS



Traditional bare house (Divaughn)

3 NARROW EAVES

3



Traditional bare house (Divaughn)

4 ROUDED CORNERS

4



Traditional bare house (Divaughn)

5 BUILT ON A MOUND TO HELP DRAINAGE AND PREVENT FLOODING

6



Traditional bare house (Divaughn)

6 HOUSES SURROUNDED BY VEGETATION WHICH REDUCES WIND IMPACTS



Traditional bare house (Divaughn)



# A LITTLE MONEY GOES A LONG WAY TO MAKING YOUR HOUSE CYCLONE RESISTANT

Making your house more cyclone resistant need not take a lot of money. But it will take plenty of planning and work. Here are some of the ways you can start to strengthen your home with small amounts of money to buy key materials

## 1. Strapping and wrapping:

1. Strapping nailed with clouts
  2. Wrapping tightly with flexible wire
  3. Reinforcing with fishing line
  4. Wrapping with coconut string or similar
  5. Nailing a block of wood
- Joints can be strengthened by longer nails, using square twist nails, and skewing them at an angle.

## BUT EVERY JOINT NEEDS MORE THAN NAILS

## 2. Shutters:

Make shutters for every window. These can be made using either timber or CGI. Keep the cyclone on the outside of your house.

## 3. Brace your roof, walls and stumps:

Diagonal bracing from the top to the bottom of each of your wall and roof panels increases the strength of your house to resist collapse.

## 4. Replace roofing nails with cyclone screws:

This can be done bit by bit as you can afford it. Start around the edges as this is where the roof can start to lift. Screw every ridge.

## 5. Pour concrete anchors with exposed rings or hooks

These can be used to tie ropes over your house. Make sure the concrete is wider at the bottom than at the top.

## 6. Build your toilet properly

Many toilets are the first structures to get blown away. Repairs can be expensive, not to mention the inconvenience of having no toilet.

refer to the Home Builders Manual [www.mit.gov.fj](http://www.mit.gov.fj) for more information

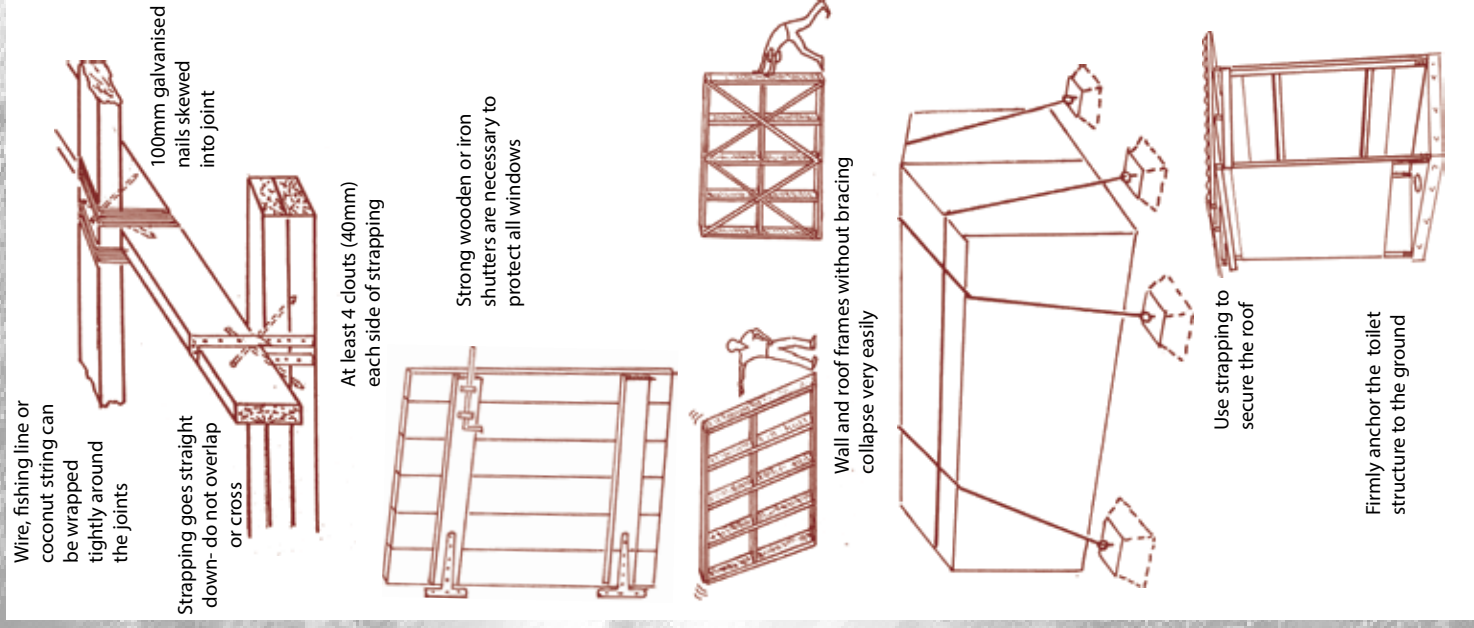

# Tips to Build Back Safer



**Shelter Cluster Fiji**  
ShelterCluster.org  
Coordinating Humanitarian Shelter



**Shelter Cluster Fiji**  
ShelterCluster.org  
Coordinating Humanitarian Shelter



International Federation  
of Red Cross and Red Crescent Societies



**Australian  
Aid**

# WHEN NAILS ARE NOT ENOUGH

All the materials that make up a house have to be strongly joined to each other, and then the whole house has to be firmly anchored to the ground.

When a house is subjected to the force of a cyclone, nails are not strong enough to hold it together. Where materials are joined together, those joints must be reinforced with one or more of the following:

- ✓ longer nails strengthen joints, especially if they are twisted and skewed.
- ✓ Screws hold stronger than nails
- ✓ and coachbolts are stronger than screws
- ✓ joints that are drilled and bolted are the strongest.

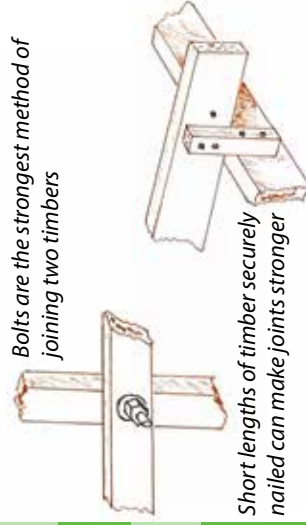

All the above methods of fixing a joint are made stronger by the use of strapping, wire, fishing line or wooden blocks.

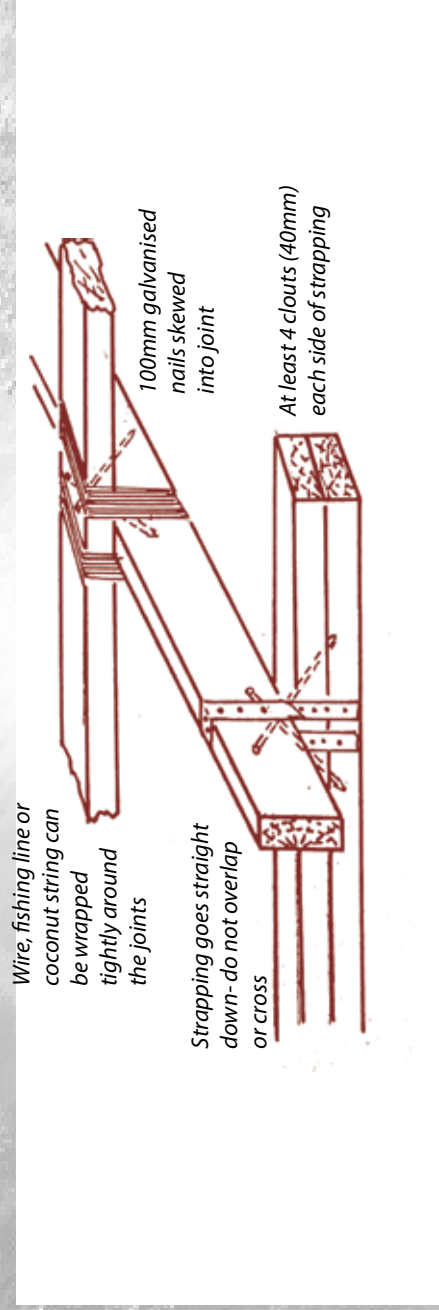

Where two or more lengths of timber meet, as in roof trusses, the joints can be further reinforced by metal or plywood plates that are screwed or nailed over the joint.

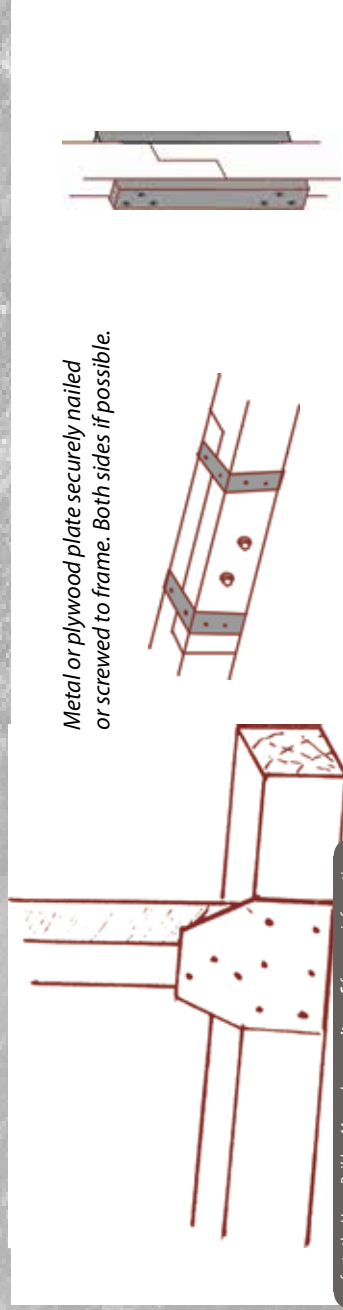

refer to the Home Builders Manual [www.mit.gov.fj](http://www.mit.gov.fj) for more information

# Tips to Build Back Safer



Shelter Cluster Fiji  
ShelterCluster.org  
Coordinating Humanitarian Shelter



Shelter Cluster Fiji  
ShelterCluster.org  
Coordinating Humanitarian Shelter



International Federation  
of Red Cross and Red Crescent Societies



Australian  
Aid



# Tips to Build Back Safer



## Retrofit Your **EXISTING** House For Cyclones

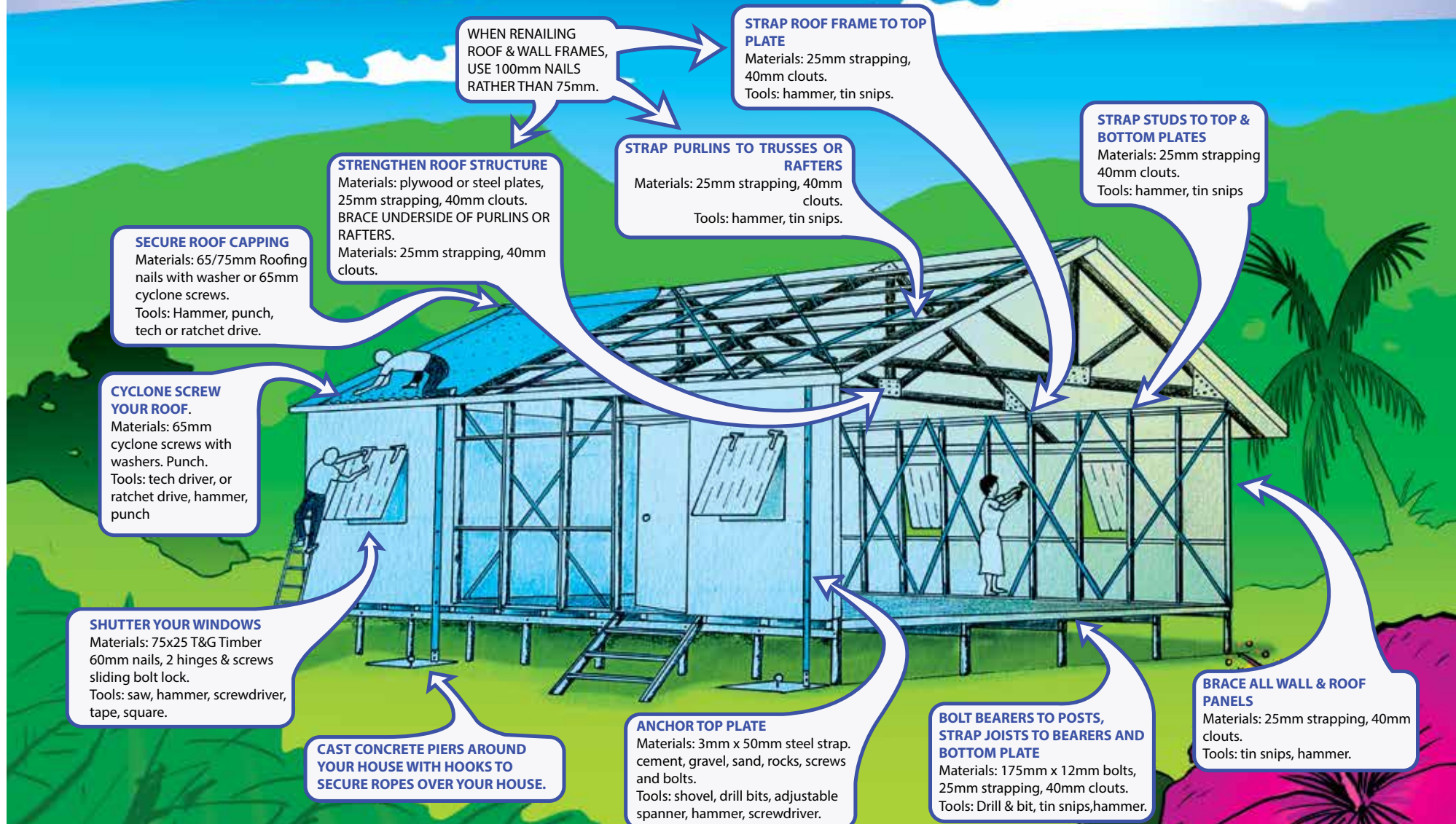

# Tips to Build Back Safer



Core shelter built after TC Winston (Fiji Red Cross/IFRC)



Habitat for Humanity Fiji team at work to build shelters and train people to build back safer. (Contact hfhfiji@habitatfiji.org.fj Ph: 3312012)

## Resources on Building Back Safer

- ✓ Shelter Cluster Fiji's goal is to provide people affected by natural disasters with the means to live in safe, dignified and appropriate shelter. The government is leading the cluster through the Ministry of Local Government, Housing & Environment. A lot of free guidance and references are available on the Shelter Cluster Fiji Website.  
<http://sheltercluster.org/library/fiji-building-back-safer-technical-library>
- ✓ The National Building Code of Fiji is a working document used mainly by building professionals operating in the private industry and the regulating authorities within the urban centres. It was determined that the essence of the Code should be made available to a wider audience by interpreting best practice for the most commonly constructed types of housing. The "Home Builders Manual" interpreted code requirements to the then current building practices. This manual provides practical guidelines for the construction of one/two storey houses, plus explains design and siting requirements, as well as fixings, for what would now be described as a Build Back Safer approach with the home owner/builder or residential builder in mind.  
<http://www.mit.gov.fj/images/2016/home%20building%20manual%20fiji.pdf>
- ✓ For issues related to accessibility, you could contact Pacific Disability Forum on [pdfsec@unwired.com.fj](mailto:pdfsec@unwired.com.fj) and <http://www.pacificdisability.org/>
- ✓ The International Federation of Red Cross and Red Crescent Societies (IFRC) has developed a "Shelter Safety handbook" with additional guidance on Build Back Safer  
<http://www.ifrc.org/PageFiles/95526/publications/305400Shelter%20safety%20handbook-EN-LR.pdf>
- ✓ CBM, Handicap International and IFRC have developed the "All Under One Roof: Disability-inclusive shelter and settlements in emergencies" guidelines  
<http://www.ifrc.org/Global/Documents/Secretariat/Shelter/All-under-one-roof-EN.pdf>



© Shelter Cluster Fiji, 2016. This is an open source document. Copies of all or part of this manual may be made for noncommercial use, providing the source is acknowledged.

Proper construction of the structures and techniques in this brochure, remain the responsibility of the individual, company or organization constructing them.

The *Help for Homes, tips to Build Back Safer* booklet has been developed by the Shelter Cluster Fiji to support Fijians self-recovery towards reconstruction of safer houses after TC Winston. Thanks to these partners for their contribution.



International Federation of Red Cross and Red Crescent Societies



the power of humanity



The Netherlands Red Cross





**First edition, Shelter Cluster Fiji, September 2016**

